

CAMUT BAND LIGHTING PLOT

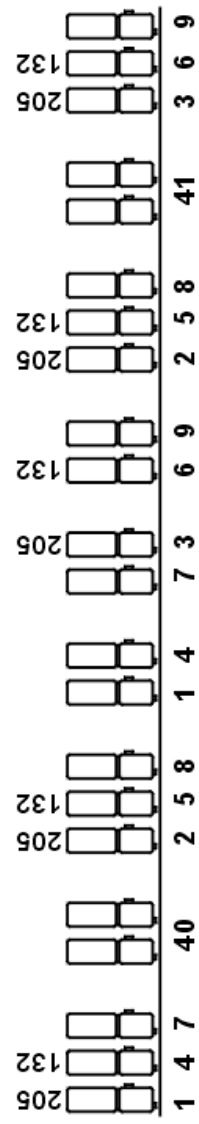
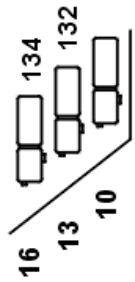
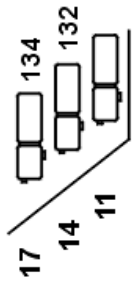
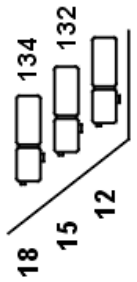
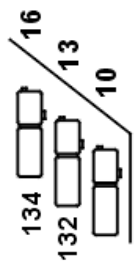
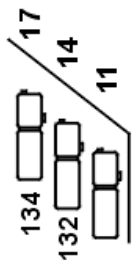
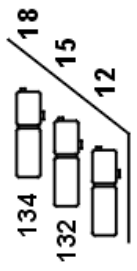
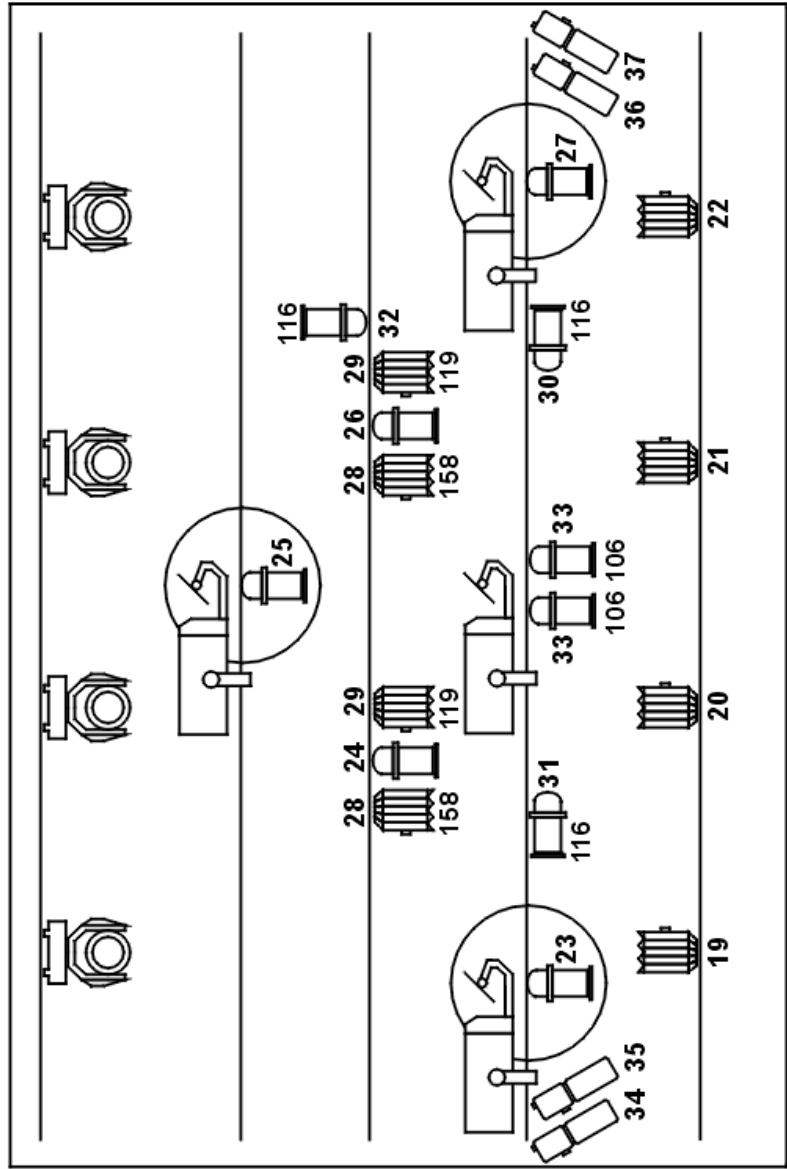

The frontal bar should be (whenever possible) at 45° from the center of the stage. For example at 7 mtrs from the center out and 7 mtrs height.

- 24 Profiles 22° 40°
- 4 Profiles 18° 32°
- 22 Profiles 11° 22°
- 10 PC 1 KW
- 8 Par 64 PC 60
- 2 Par 64 PC 62
- 4 Mac 600 Martin
- 4 Pal Martin 1200
- 1 Lighting desk M.A. Scancammander
- Lee filters: 134, 132, 106, 158, 119, 205 and 116.
- Minimum bar height 6 mts.
- Maximum bar height 7,5mtrs.

CAMUT BAND: STAGE MOVEMENT

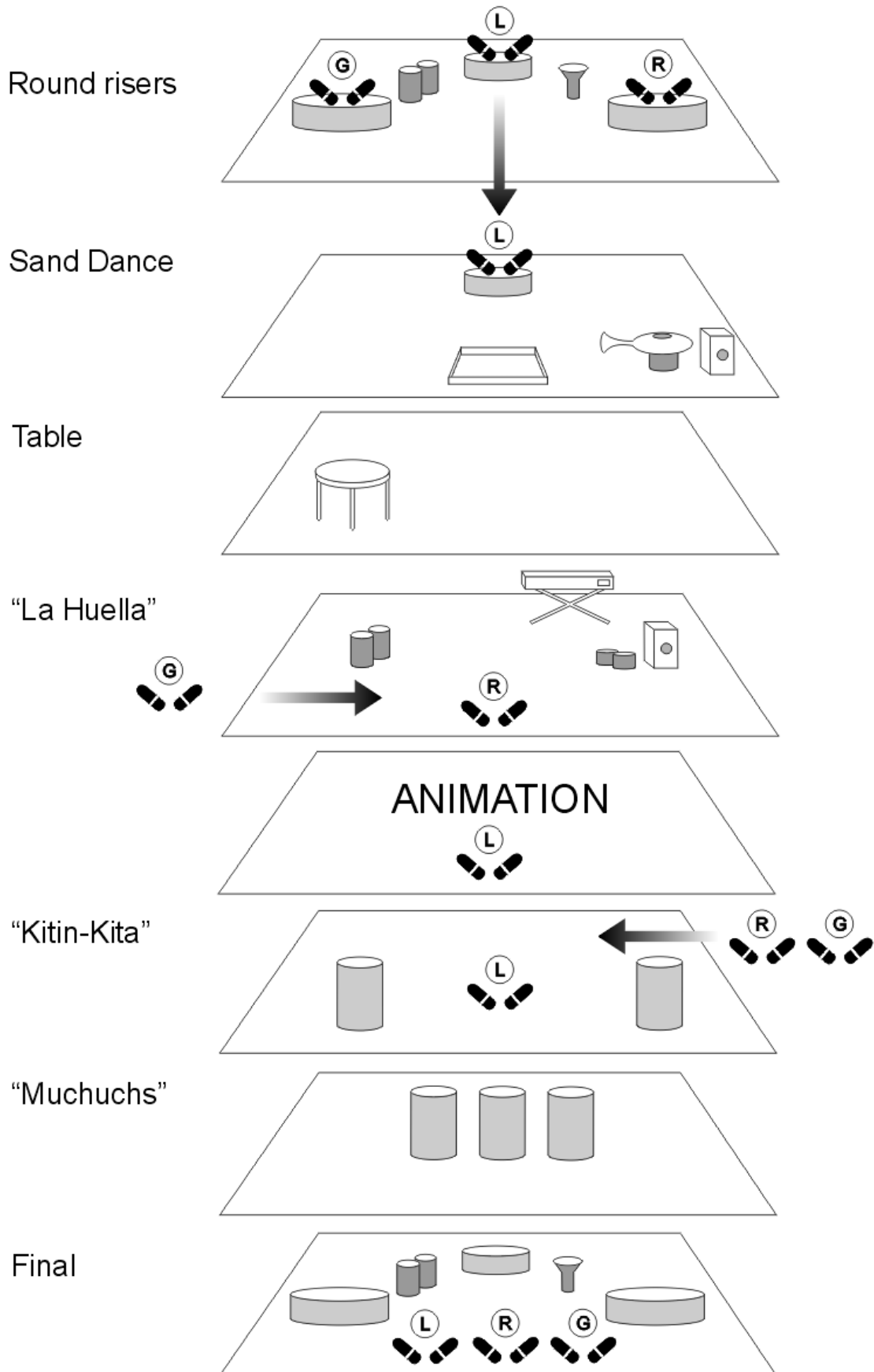

CAMUT BAND: STAGE

LIFE IS RHYTHM

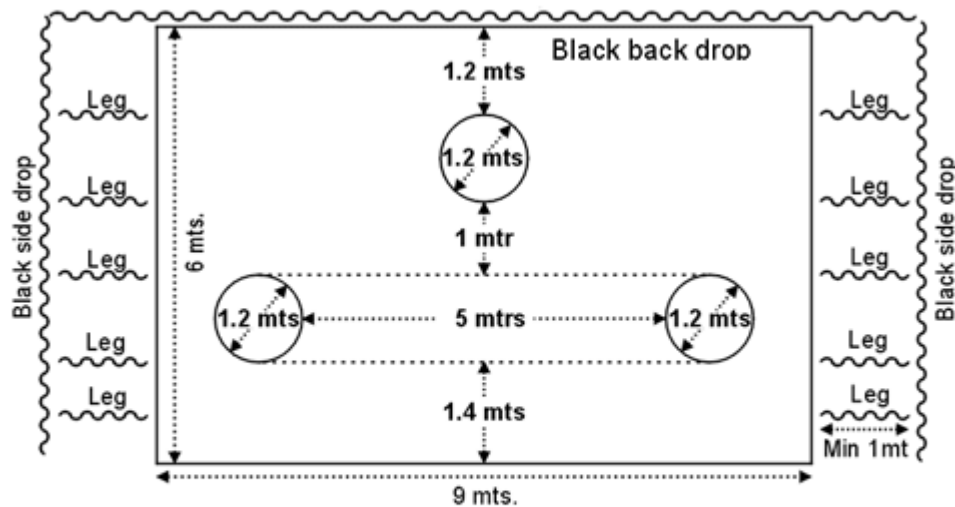

The stage floor must be made of wood, painted with matt black paint.

There must be no changes in level or gaps between the joints, there must be a smooth flat surface and the sheets of wood have to be firmly fixed together. There must be no nails or screw-heads sticking out of the surface.

The surface must not be slippery, with no wax or varnish treatment and should be washed with water only (no chemical cleaning products).

There must be black back and side drops and 10 black legs (5 on each side). The legs should be at least 1 meter wide.

For seasons or tours lasting longer than 2 weeks there must be a sprung (floating) wooden floor or a wooden floor resting on 2 cm of conglomerated foam, (sports floor).

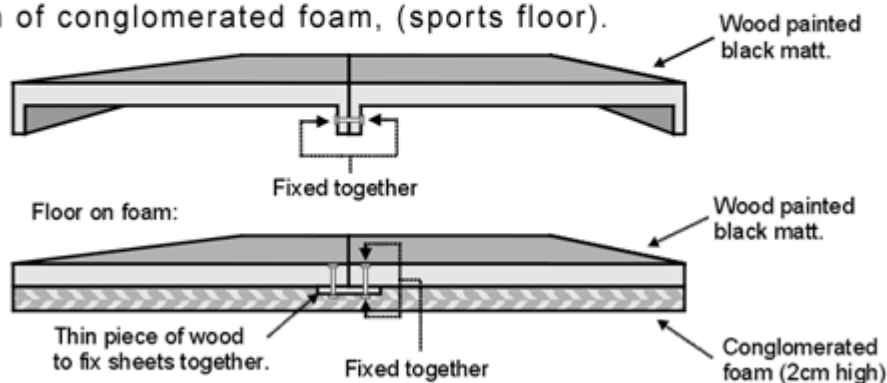

Dressing rooms:

We need 2 showers with hot water, a table, 7 chairs, a mirror and bottles of mineral water (without gas) to drink.

CAMUT BAND : SOUND

LIFE IS RHYTHM

1 of 2 pages
October 2003

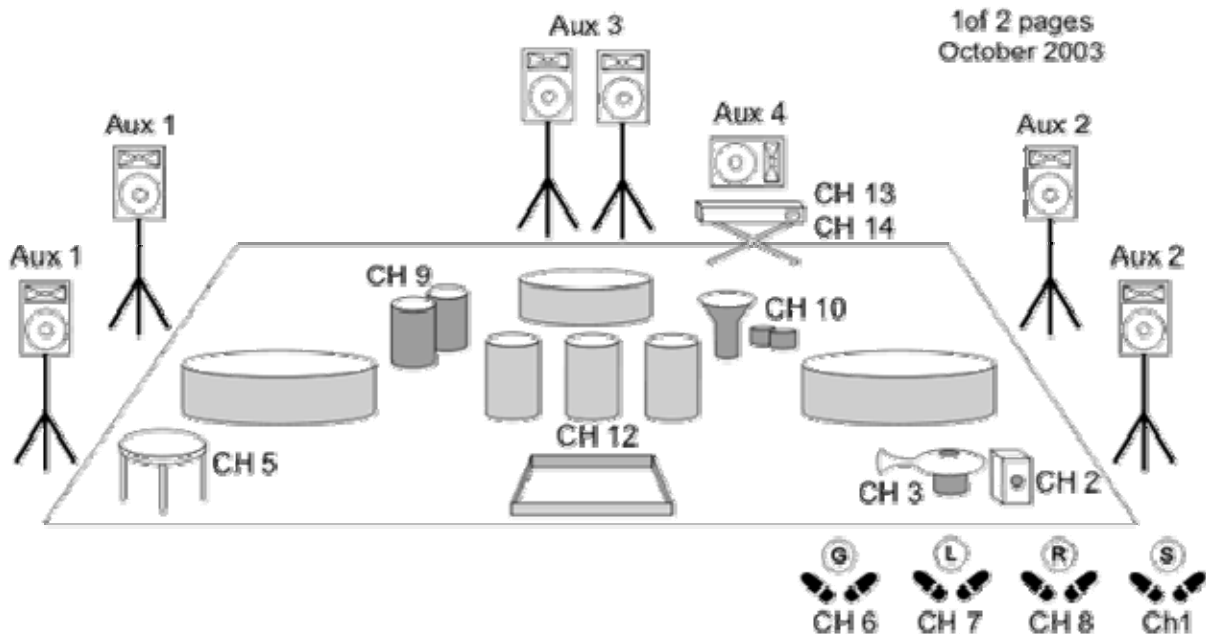

Channel List

1	Tap 4	We provide a wireless mic	
2	Cajón	Shure 57	No stand
3	Udu	Shure 58	Long boom stand
4	Sand	The same signal as channel 6 ("y")	
5	Table	Shure 58	No stand
6	Tap 1	We provide a wireless mic	
7	Tap 2	We provide a wireless mic	
8	Tap 3	We provide a wireless mic	
9	Percussion L	Shure 58	Short boom stand
10	Percussion R	Shure 58	Short boom stand
11	Low	The same signal as channel 7 ("y")	
12	Voice	Shure 58	Long boom stand
13	Piano	Di	
14	Piano	Di	
15	CD L		Aux 1 Left side fill monitors.
16	CD R		Aux 2 Right side fill monitors.
17	Fx1 L		Aux 3 Back monitors.
18	Fx1 R		Aux 4 Piano monitor.
19	Fx2 L		Aux 5 Fx1
20	Fx2 R		Aux 6 Fx2
21	Spare	We provide a wireless mic	

CAMUT BAND SOUND: LIFE IS RHYTHM

2 of 2 pages

Instruments

1 Electric piano with a sustain pedal, and a sturdy, low piano stand (the musician plays sitting down). 88 pressure sensitive keys with real piano feel and high quality piano sounds. Roland Rd300, Rd600 or similar would be good.

P.A.

A 3 or 4 way active system capable of producing high quality music in all the area. The sub bass bins must be at floor level or on the stage floor, *not hung or in high balconies*. The system must be stereo.

Whenever possible the high-mid boxes should be hung. For long venues boxes will be distributed with delays and on wide stages frontfills (or a mid cluster) will be used to provide an even level throughout the venue.

4.000W minimum capacity for indoor venues, 8.000W for open air. There should be about 5W per person indoors and out (eg. 2,000 people 10,000W).

Monitors

We need 7 active (bi-amped) monitors with 6 stands (tripods).

6 of the monitors have to go on stands at head height, therefore they have to be boxes designed to go on stands (Meyer Upas or similar). The piano monitor can be a floor monitor (wedge). The monitors will be in 4 auxiliary sends.

Sound Desk

A professional 24 channel desk with 6 auxiliary sends, 4 band parametric e.q., high pass filter, pad, fader and phantom power on each channel. 4 of the auxiliary sends will be pre fader for monitors and 2 post fader for fx.

A 24 channel multicore with a stages box.

1 C.D. player.

2 Multi fx (SPX 900, SPX 990 or similar)

4 Compressors.

1 Gate.

3 Klark Teknik DN360 stereo graphic E.Q.'s

The sound desk will be operated during the show and sound check by our sound technician.

The sound desk must be in a position with a full view of the stage and a decent acoustic reference *this will be subject to the criteria of our sound technician*.

Please send us a detailed list of all the material that you will provide, as soon as possible. If you have any questions please do not hesitate to contact us.

Thank you.

CAMUT BAND / LA VIDA ES RITMO

BOHEDA AUDIO

Strumenti:

Tastiera con pedale e con supporto basso (il musicista suona seduto) 88 tasti pressure sensitive con buona qualità di suono come ad esempio una Roland Rd 300 o Rd 600 .

P.A.

Un sistema audio a 3 o 4 vie, capace di riprodurre musica di alta qualità nell'intera area. Le casse dei bassi devono trovarsi al livello del terreno o sul pavimento del palcoscenico Non devono essere sospese o trovarsi su delle balconate. Il sistema deve essere stereo. Ove possibile, le casse degli alti e medi dovranno trovarsi sospese. Per i luoghi molto ampi le casse saranno distribuite con linee di ritardo e saranno utilizzate in modo da coprire la superficie di ascolto in maniera equilibrata.

Sono necessari 4000W di potenza minima per le rappresentazioni nei luoghi chiusi e 8000W per le rappresentazioni open air. Dovrebbero esserci almeno 5W a persona (es. 2000 persone 10000 W)

Monitor:

7 monitor attivi(bi-amped) e 6 stativi.

6 monitor devono stare sugli stativi ad altezza uomo e devono essere concepiti per essere sospesi (Upas de Meyer o simili). Il monitor della tastiera potrà essere un modello da terra (wedge) . I monitor avranno 4 invii ausiliari.

Console audio:

Desk professionale da 24 canali , 6 auxiliary sends, 4 tracce di equalizzatori, high pass filter, pad, fader e phantom power per ogni canale. 4 dei 6 auxiliary sends saranno pre-fader per monitor e 2 post-fader per fx.

Un 24 canali multicore con stages box

1 CD player

2 Multi fx (SPX900, SPX990 o simile)

4 Compressors

1 Gate

3 Klark Teknik DN360 stereo graphic E.Q.'s

La console deve essere ben visibile dal palco. Sarà utilizzata e controllata durante le prove e lo spettacolo dal nostro fonico.

Per cortesia inviateci una vostra lista dettagliata di tutto il materiale audio disponibile al più presto. Contattateci per qualsiasi dubbio o informazione ulteriore